



MSL1

* Pb Free Part

Customer Name	Standard	TAIYO YUDEN Mobile Technology Co.,Ltd.	
System	EGSM-Rx (50/150)	Date	March 31, 2010
Part Number	FAR-F5KB-942M50-B4EB	Version 4.0 d	

Table 1 Electrical Specification

Passband : 925 ~ 960 MHz						
Item	Condition (MHz)	Specification			Unit	Remark
		Min.	Typ.	Max.		
Insertion Loss	925 ~ 960	-	1.6	2.5	dB	
Ripple	925 ~ 960	-	0.4	1.6	dB	
Absolute attenuation	DC ~ 880	40	66	-	dB	
	880 ~ 905	30	38	-	dB	
	905 ~ 915	18	26	-	dB	
	980 ~ 1025	25	33	-	dB	
	1025 ~ 2880	36	50	-	dB	
	2880 ~ 6000	30	50	-	dB	
VSWR(Input)	925 ~ 960	-	1.7	2.0	-	
VSWR(Output)	925 ~ 960	-	1.6	2.0	-	
Amplitude Balance (S ₂₁ /S ₃₁)	925 ~ 960	-1.0	0/ +0.5	+1.0	dB	
Phase Balance ((∠S ₂₁ -∠S ₃₁)+180)	925 ~ 960	-10	0/+4	+10	deg	
Input Impedance	Unbalanced	50			ohm	
Output Impedance	Balanced	150//82nH			ohm	
Input Power	925 ~ 960	-	-	+13	dBm	
Operating temperature		-30 ~ +85			°C	
Device size		1.4typ. x 1.0typ. x 0.50typ.			mm	



MSL1

* Pb Free Part

Customer Name	Standard	TAIYO YUDEN Mobile Technology Co.,Ltd.	
System	EGSM-Rx (50/150)	Date	March 31, 2010
Part Number	FAR-F5KB-942M50-B4EB	Version	4.0 d

Dimension

Device size: 1.4typ. x 1.0typ. x 0.50typ.

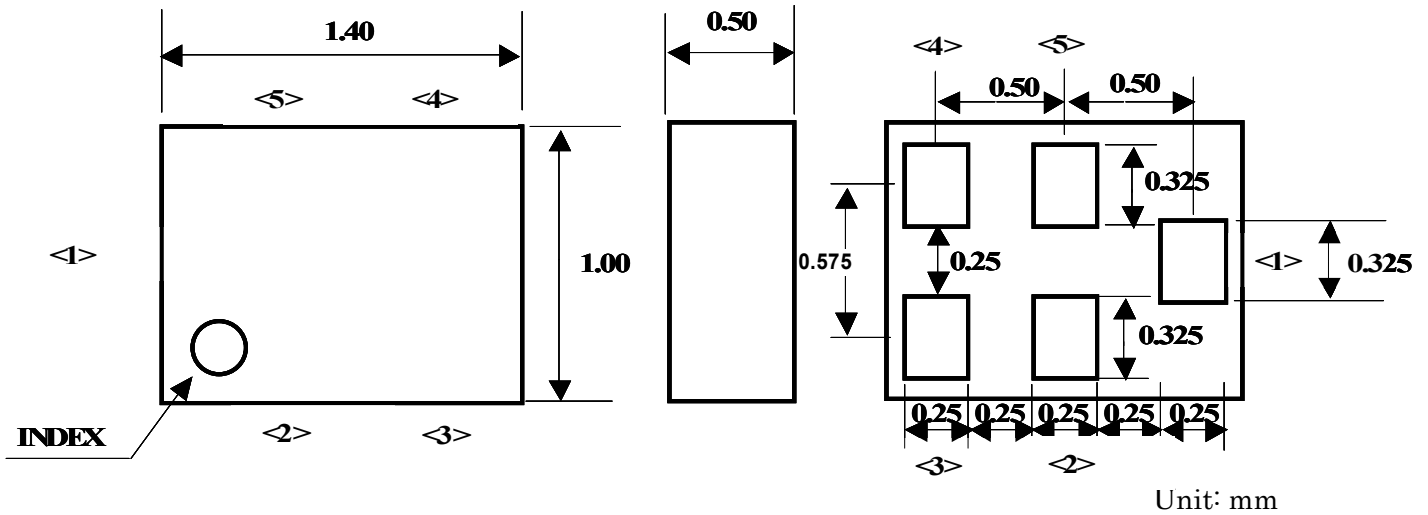

Pin Configuration

Pin No.	Symbol	Function
1	IN	Unbalanced pin
2	GND	Ground
3	OUT	Balanced pin
4	OUT	Balanced pin
5	GND	Ground

Evaluation Circuit

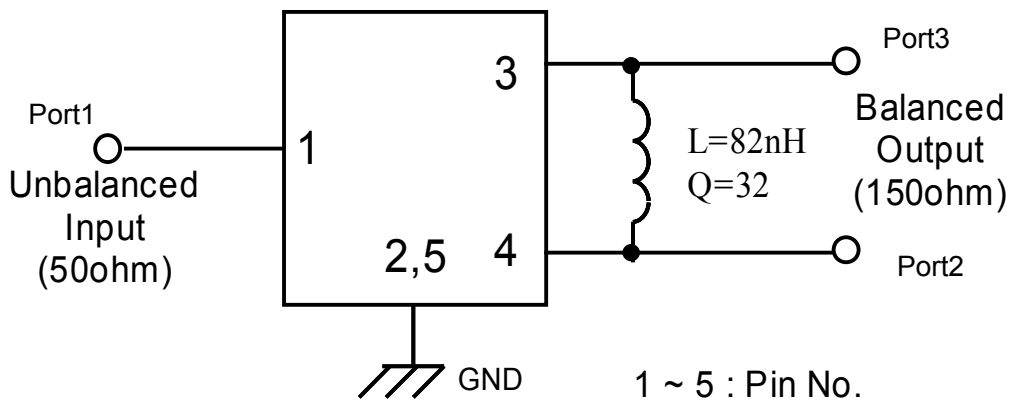



MSL1

* Pb Free Part

Customer Name	Standard	TAIYO YUDEN Mobile Technology Co.,Ltd.	
System	EGSM-Rx (50/150)	Date	March 31, 2010
Part Number	FAR-F5KB-942M50-B4EB	Version 4.0 d	

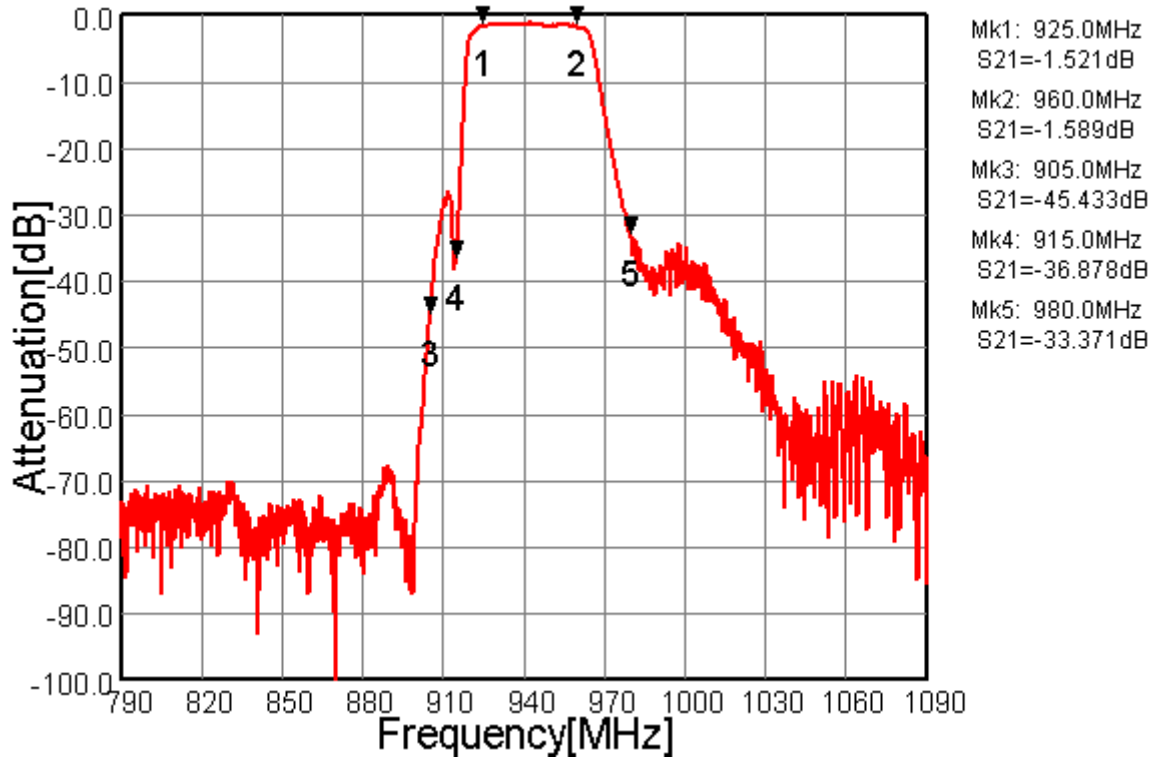

Fig.1 Pass-band Characteristics

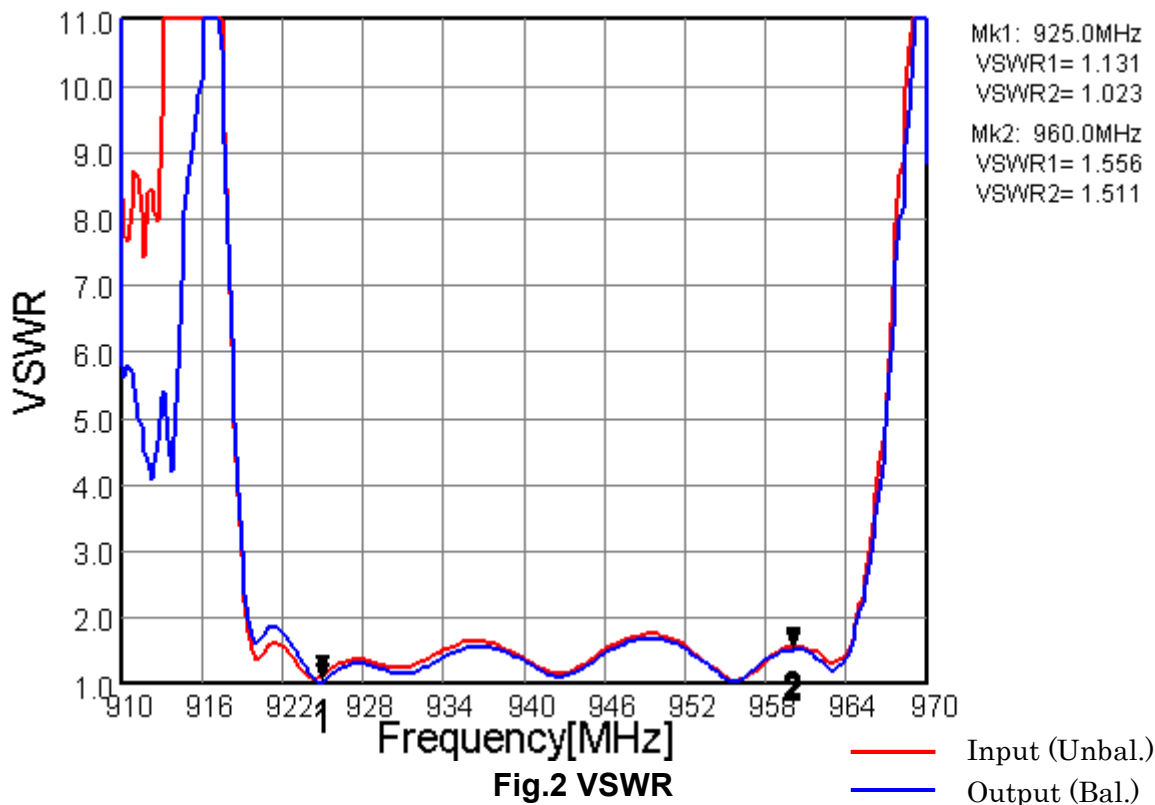

Fig.2 VSWR



MSL1

* Pb Free Part

Customer Name	Standard	TAIYO YUDEN Mobile Technology Co.,Ltd.	
System	EGSM-Rx (50/150)	Date	March 31, 2010
Part Number	FAR-F5KB-942M50-B4EB	Version 4.0 d	

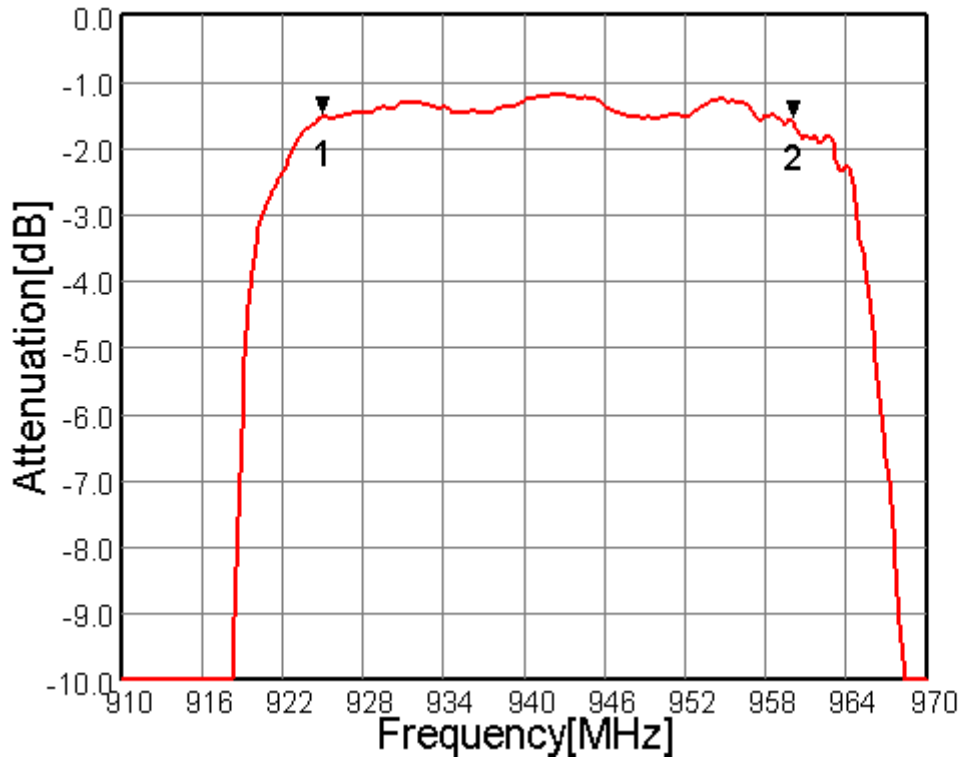

Fig.3 In-band Characteristics

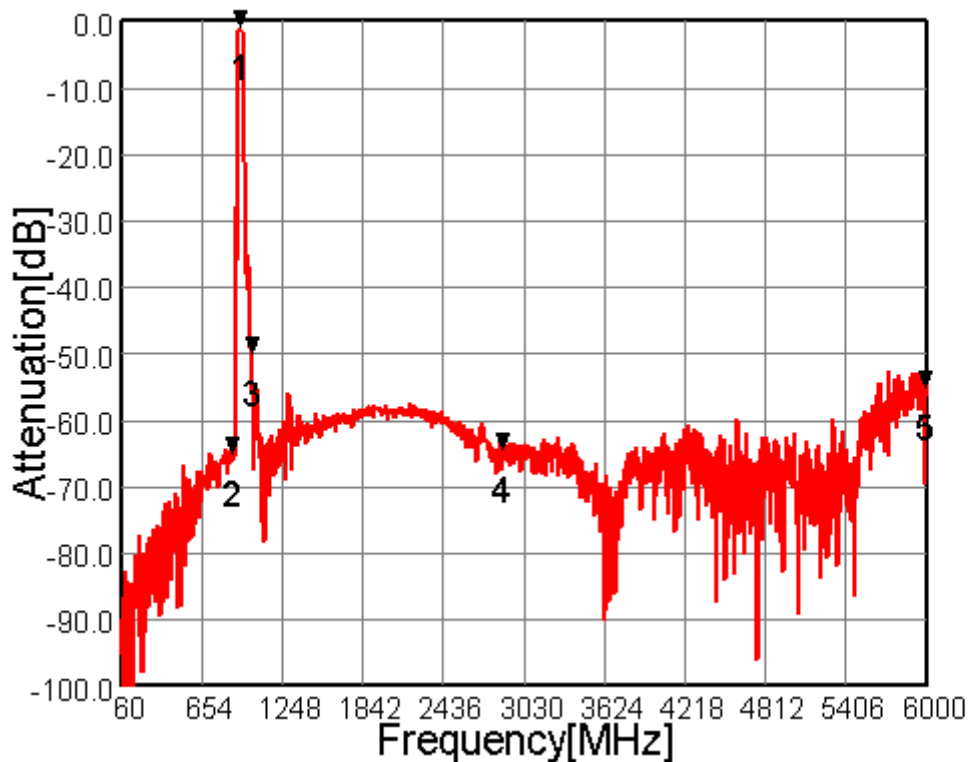

Fig.4 Wide-band Characteristics



MSL1

* Pb Free Part

Customer Name	Standard	TAIYO YUDEN Mobile Technology Co.,Ltd.	
System	EGSM-Rx (50/150)	Date	March 31, 2010
Part Number	FAR-F5KB-942M50-B4EB	Version 4.0 d	

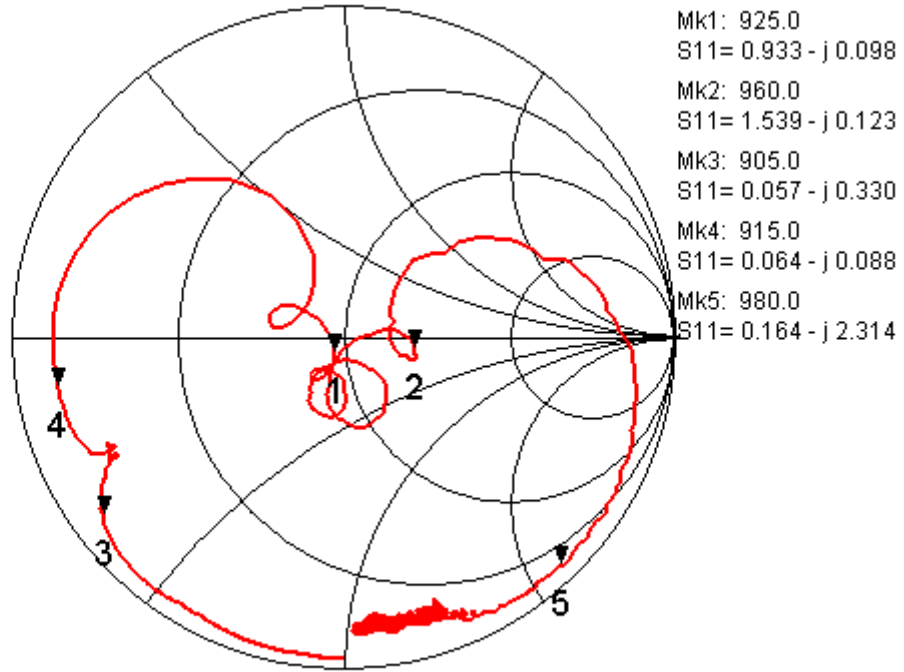

Fig.5 Input Impedance (Unbalance)

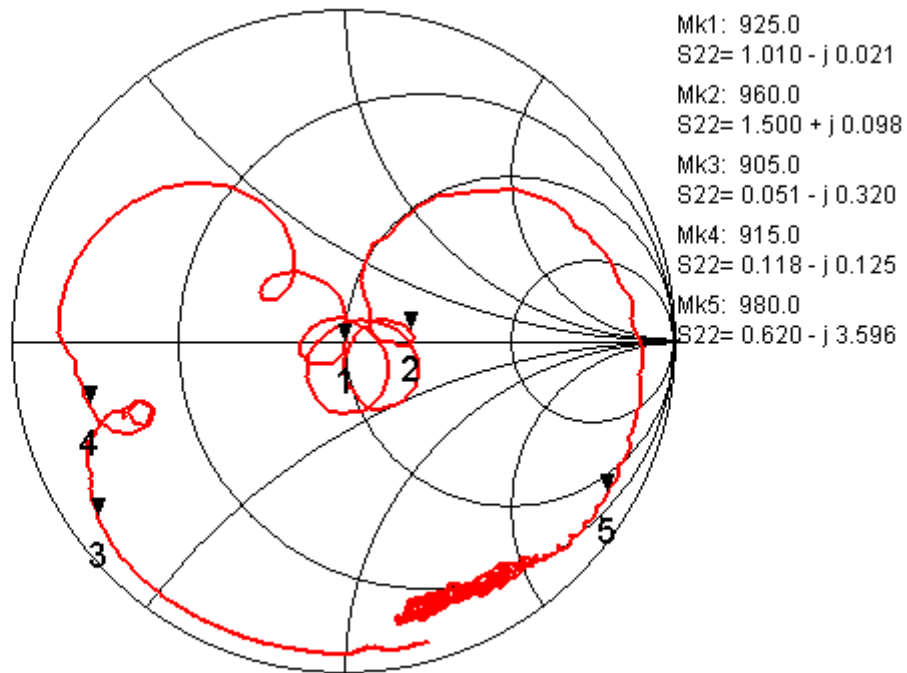

Fig.6 Output Impedance (Balance)



MSL1

* Pb Free Part

Customer Name	Standard	TAIYO YUDEN Mobile Technology Co.,Ltd.	
System	EGSM-Rx (50/150)	Date	March 31, 2010
Part Number	FAR-F5KB-942M50-B4EB	Version 4.0 d	

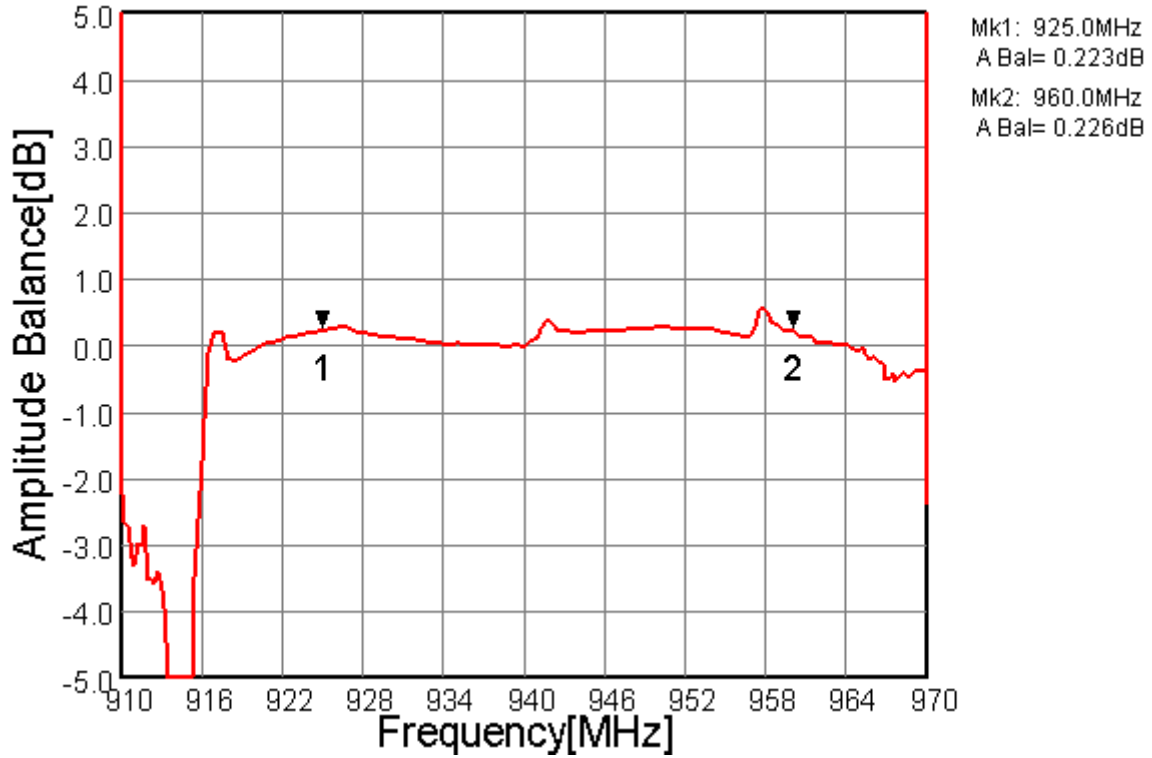

Fig.7 Amplitude Balance

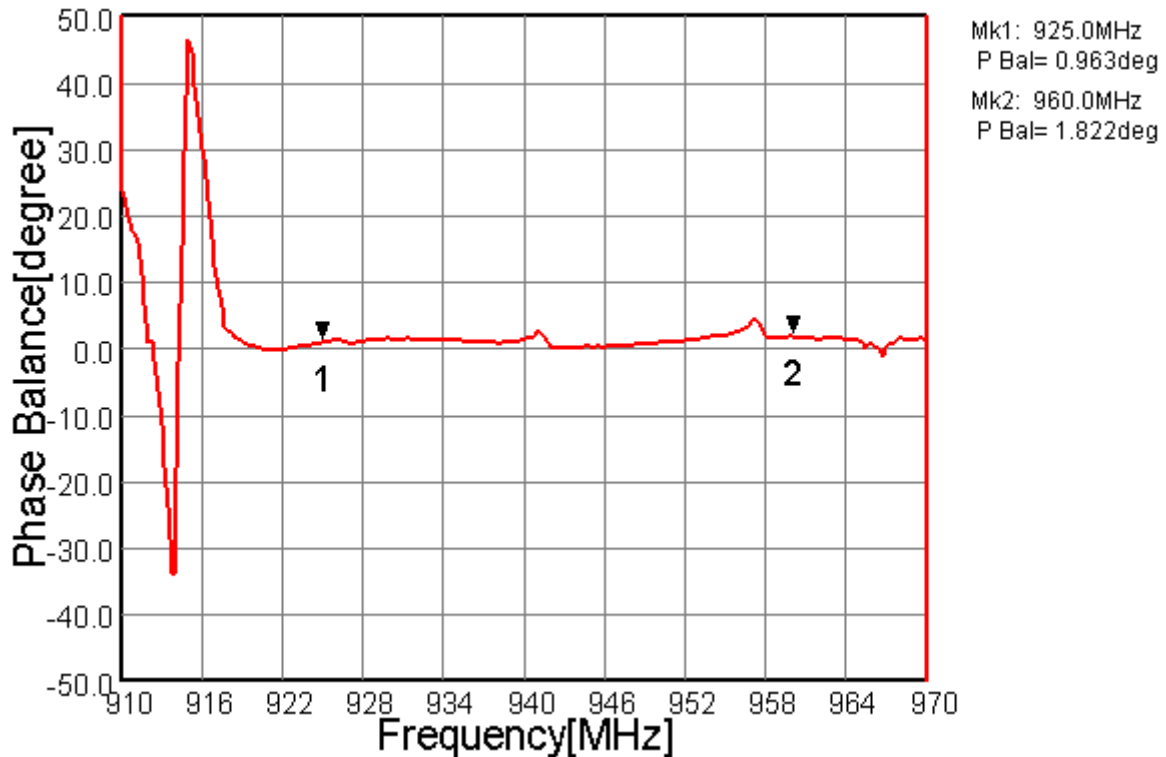

Fig.8 Phase Balance