

PC852X Series PC853X Series

DIP 4pin Darlington Phototransistor Output,
High Collector-emitter Voltage
Photocoupler

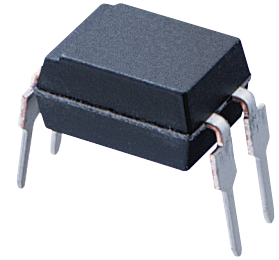

■ Description

PC852X Series/PC853X Series contains an IRED optically coupled to a phototransistor.

It is packaged in a 4-pin DIP, available in SMT gullwing lead-form option.

Input-output isolation voltage(rms) is 5.0kV.

Collector-emitter voltage is 350V and CTR is MIN. 1 000% at input current of 1mA.

■ Features

1. 4pin DIP package
2. Double transfer mold package (Ideal for Flow Soldering)
3. High collector-emitter voltage (V_{CEO} : 350V)
4. Darlington phototransistor output (CTR : MIN. 1 000% at $I_F=1mA$, $V_{CE}=2V$)
5. Large collector power dissipation : **PC853X** (P_C : 300mW)
6. High isolation voltage between input and output ($V_{iso(rms)}$: 5kV)

■ Agency approvals/Compliance

1. Recognized by UL1577, file No. E64380 (as model No. **PC852/PC853**)
2. Package resin : UL flammability grade (94V-0)

■ Applications

1. Telephone line interface/isolation
2. Interface to power supply circuit
3. Controller for SSRs, DC motors

Notice The content of data sheet is subject to change without prior notice.

In the absence of confirmation by device specification sheets, SHARP takes no responsibility for any defects that may occur in equipment using any SHARP devices shown in catalogs, data books, etc. Contact SHARP in order to obtain the latest device specification sheets before using any SHARP device.

Internal Connection Diagram

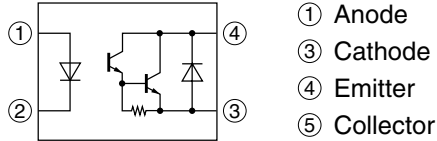

Outline Dimensions

(Unit : mm)

PC852X Series

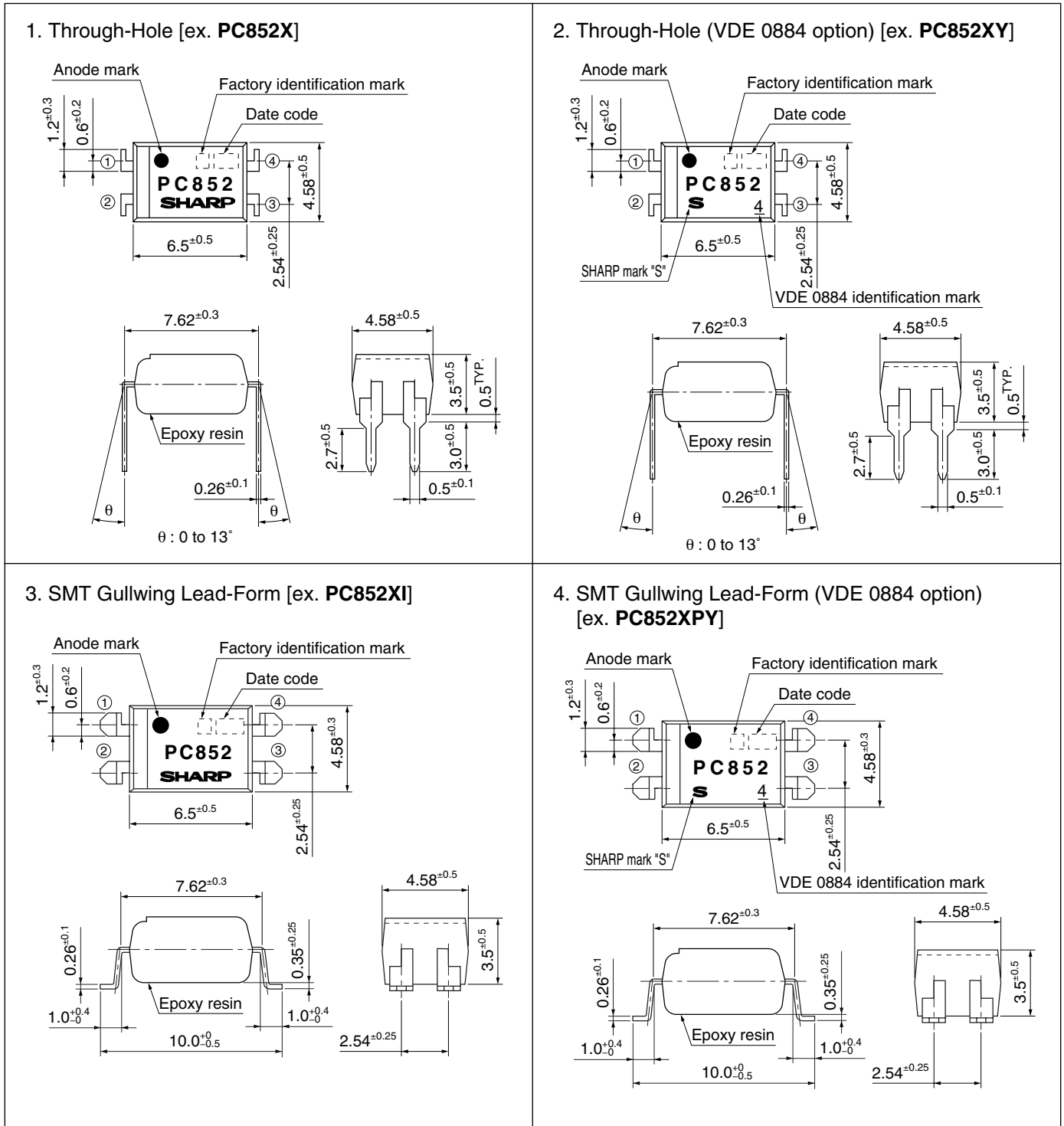

● **PC853X Series**

(Unit : mm)

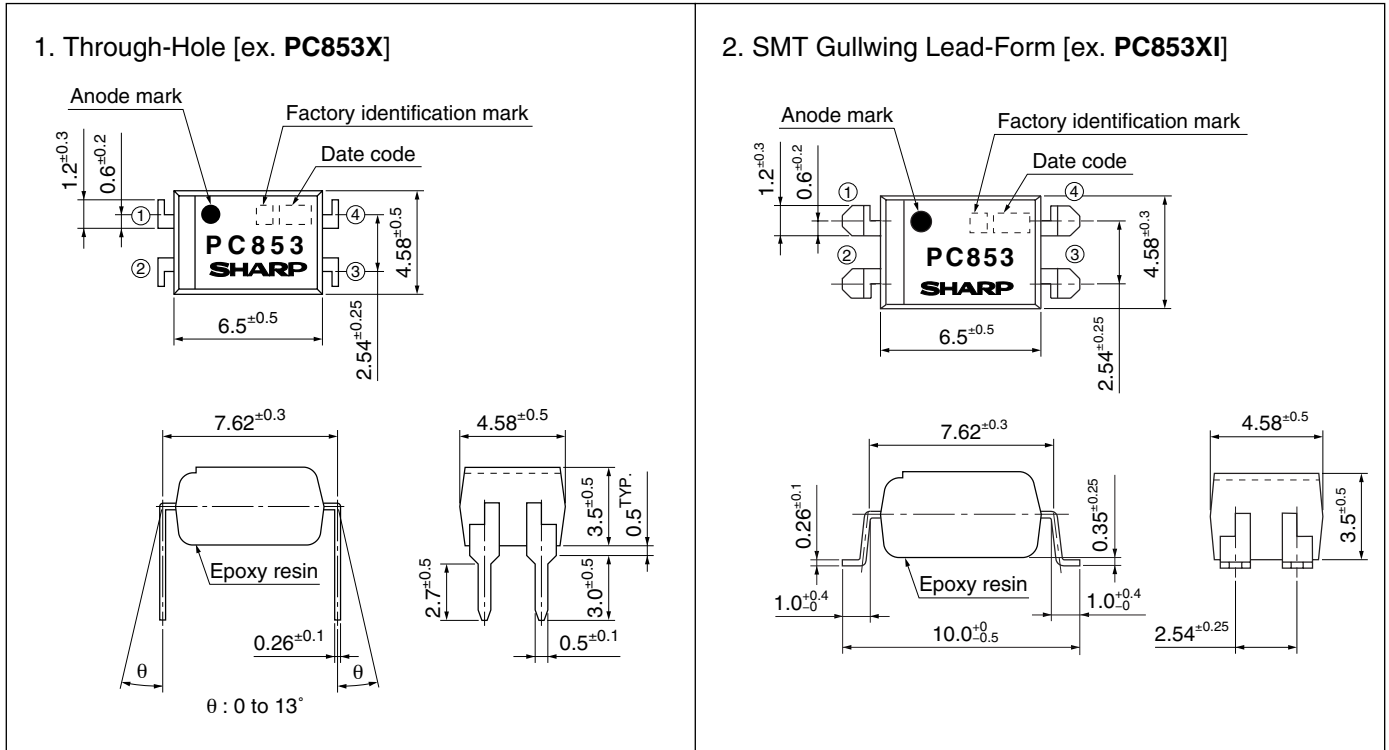





Product mass : approx. 0.21g

Date code (2 digit)

1st digit				2nd digit	
Year of production				Month of production	
A.D.	Mark	A.D.	Mark	Month	Mark
1990	A	2002	P	January	1
1991	B	2003	R	February	2
1992	C	2004	S	March	3
1993	D	2005	T	April	4
1994	E	2006	U	May	5
1995	F	2007	V	June	6
1996	H	2008	W	July	7
1997	J	2009	X	August	8
1998	K	2010	A	September	9
1999	L	2011	B	October	O
2000	M	2012	C	November	N
2001	N	∴	∴	December	D

repeats in a 20 year cycle

Factory identification mark

Factory identification Mark	Country of origin
no mark	Japan
	
	Indonesia
	Philippines
	China

* This factory marking is for identification purpose only.
Please contact the local SHARP sales representative to see the actual status of the production.

■ Absolute Maximum Ratings (T_a=25°C)

Parameter	Symbol	Rating		Unit	
		PC852X	PC853X		
Input	Forward current	I _F	50		mA
	*1 Peak forward current	I _{FM}	1		A
	Reverse voltage	V _R	6		V
	Power dissipation	P	70		mW
Output	Collector-emitter voltage	V _{CEO}	350		V
	Emitter-collector voltage	V _{ECO}	0.1		V
	Collector current	I _C	150		mA
	Collector power dissipation	P _C	150	300	mW
Total power dissipation	P _{tot}	200	320	mW	
*2 Isolation voltage	V _{iso (rms)}	5.0		kV	
Operating temperature	T _{opr}	-30 to +100		°C	
Storage temperature	T _{stg}	-55 to +125		°C	
*3 Soldering temperature	T _{sol}	260		°C	

*1 Pulse width ≤ 100μs, Duty ratio : 0.001

*2 40 to 60%RH, AC for 1 minute, f=60Hz

*3 For 10s

■ Electro-optical Characteristics (T_a=25°C)

Parameter	Symbol	Conditions	MIN.	TYP.	MAX.	Unit		
Input	Forward voltage	V _F	I _F =10mA		-	1.2	1.4	V
	Reverse voltage	I _R	V _R =4V		-	-	10	μA
	Terminal capacitance	C _t	V=0, f=1kHz		-	30	250	pF
Output	Collector dark current	I _{CEO}	V _{CE} =200V, I _F =0		-	-	200	nA
	Collector-emitter breakdown voltage	BV _{CEO}	I _C =0.1mA, I _F =0		350	-	-	V
Transfer characteristics	Collector current	I _C	I _F =1mA, V _{CE} =2V		10	40	150	mA
	Collector-emitter saturation voltage	V _{CE (sat)}	I _F =20mA, I _C =100mA		-	-	1.2	V
	Isolation resistance	R _{ISO}	DC500V, 40 to 60%RH		5×10 ¹⁰	1×10 ¹¹	-	Ω
	Floating capacitance	C _f	V=0, f=1MHz		-	0.6	1.0	pF
	Cut-off frequency	f _C	V _{CE} =2V, I _C =20mA, R _L =100Ω, -3dB		1	7	-	kHz
	Response time	Rise time	t _r	V _{CE} =2V, I _C =20mA, R _L =100Ω		-	100	300
Fall time		t _f	-			20	100	μs

■ Model Line-up

● PC852X Series

Lead Form	Through-Hole		SMT Gullwing		
Package	Sleeve		Taping		
	100pcs/sleeve		2 000pcs/reel		
VDE0884	—	Approved	—	—	Approved
Model No.	PC852X	PC852XY	PC852XI	PC852XP	PC852XPY

● PC853X Series

Lead Form	Through-Hole	SMT Gullwing	
Package	Sleeve	Taping	
	100pcs/sleeve	2 000pcs/reel	
VDE0884	—	—	—
Model No.	PC853X	PC853XI	PC853XP

Please contact a local SHARP sales representative to inquire about production status and Lead-Free options.

Fig.1 Forward Current vs. Ambient Temperature

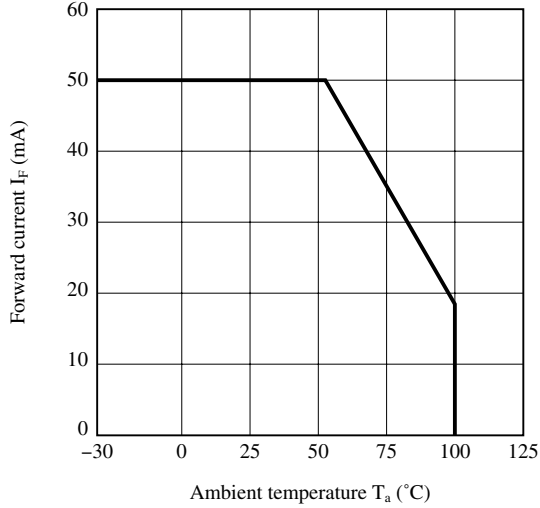

Fig.2 Diode Power Dissipation vs. Ambient Temperature

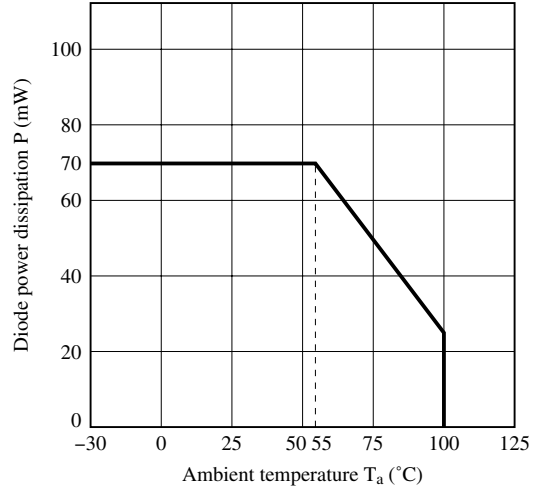

Fig.3-a Collector Power Dissipation vs. Ambient Temperature (PC852X)

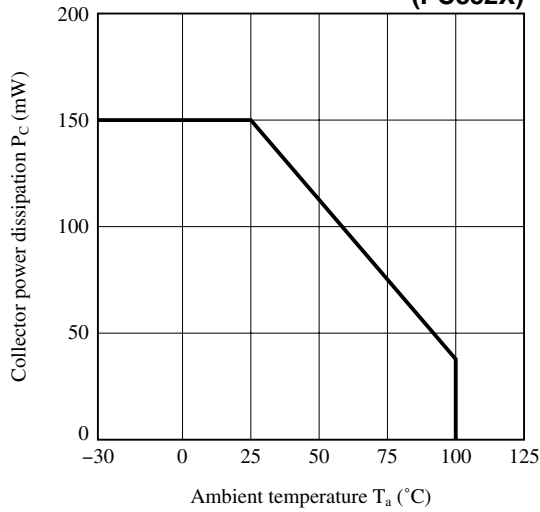

Fig.3-b Collector Power Dissipation vs. Ambient Temperature (PC853X)

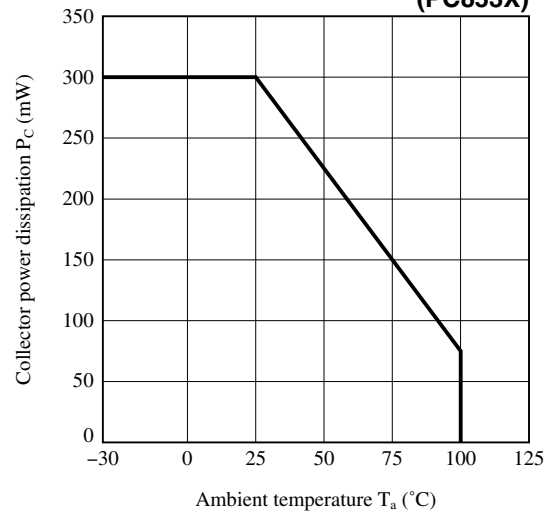

Fig.4 Total Power Dissipation vs. Ambient Temperature

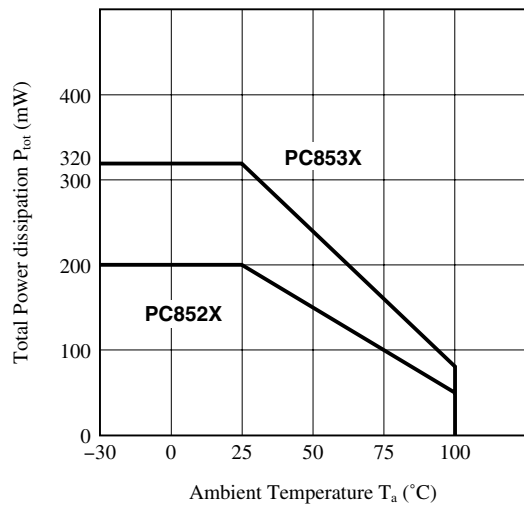

Fig.5 Peak Forward Current vs. Duty Ratio

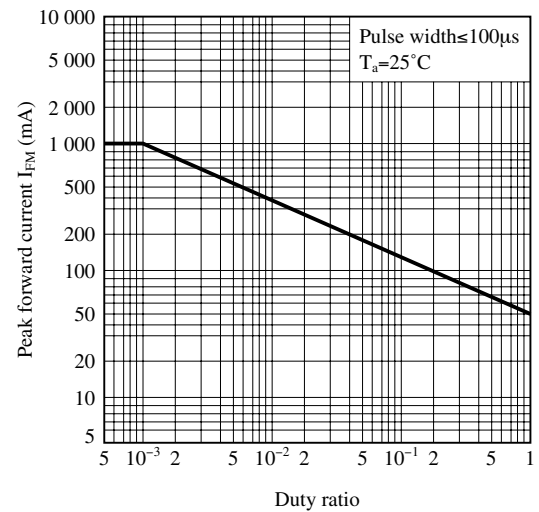

Fig.6 Forward Current vs. Forward Voltage

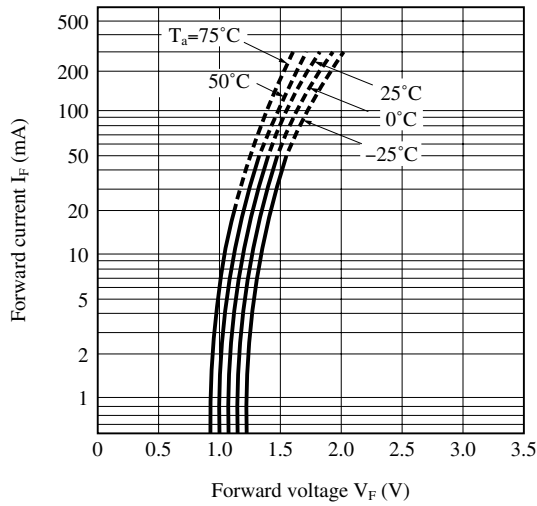

Fig.7-a Current Transfer Ratio vs. Forward Current (PC852X)

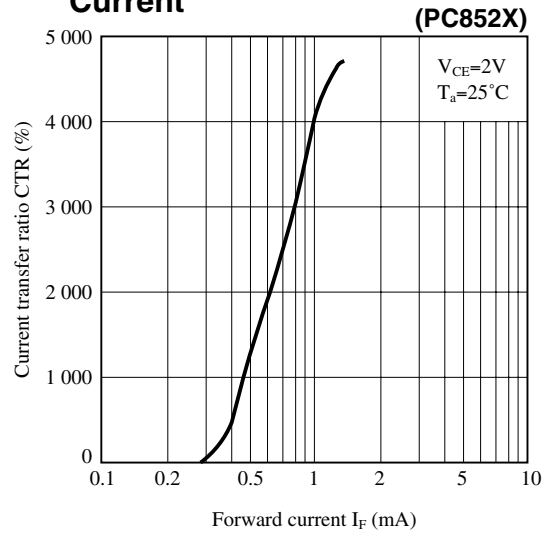

Fig.7-b Current Transfer Ratio vs. Forward Current (PC853X)

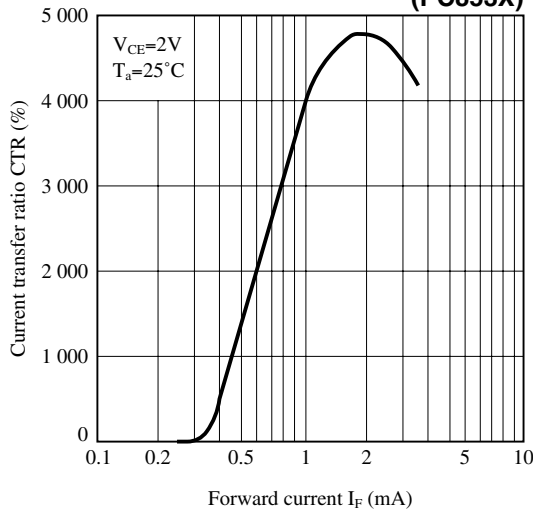

Fig.8-a Collector Current vs. Collector-emitter Voltage (PC852X)

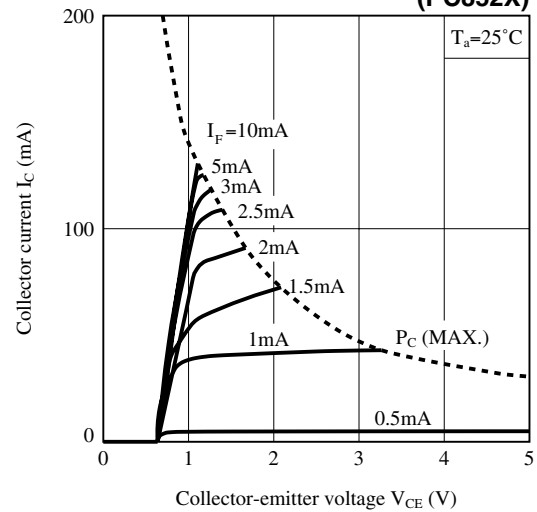

Fig.8-b Collector Current vs. Collector-emitter Voltage (PC853X)

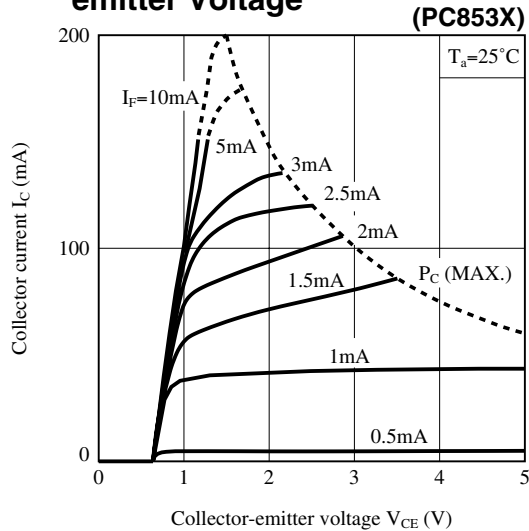

Fig.9 Relative Current Transfer Ratio vs. Ambient Temperature

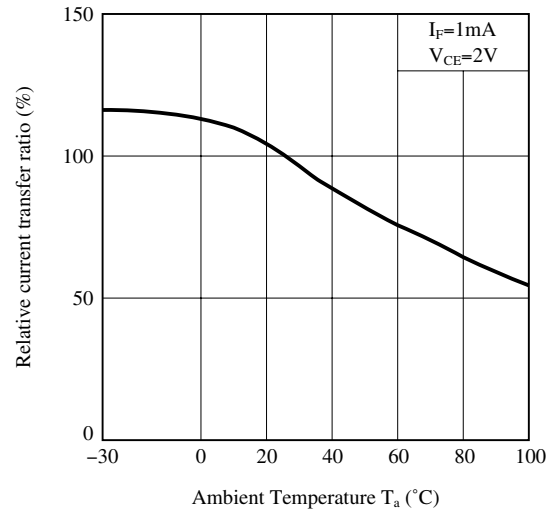

Fig.10 Collector - emitter Saturation Voltage vs. Ambient Temperature

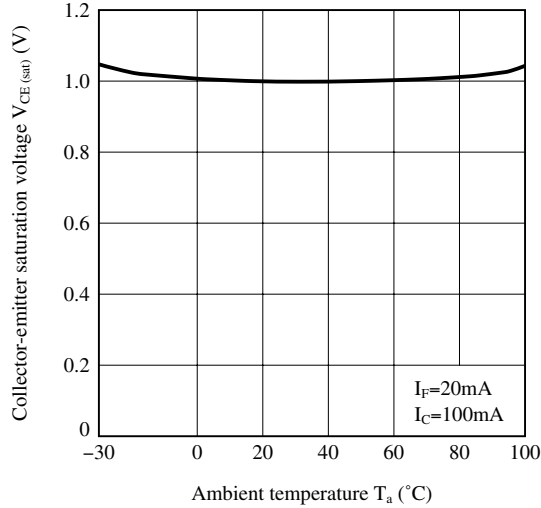

Fig.11 Collector Dark Current vs. Ambient Temperature

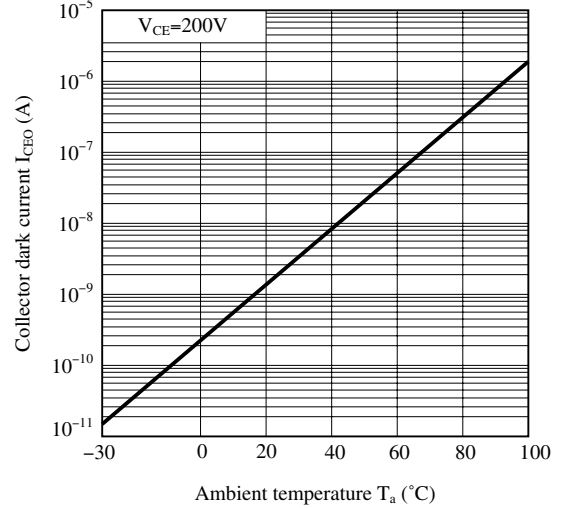

Fig.12 Response Time vs. Load Resistance

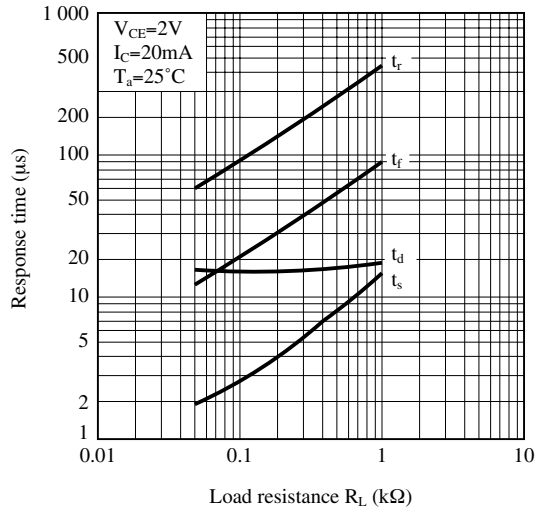
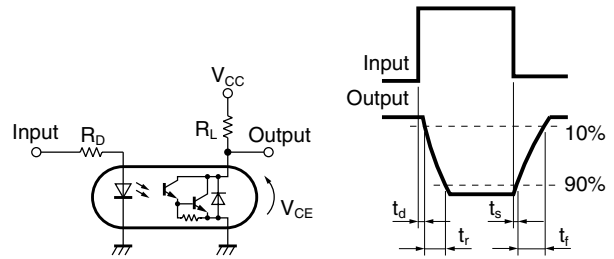

Fig.13 Test Circuit for Response Time



Please refer to the conditions in Fig.12.

Fig.14 Frequency Response

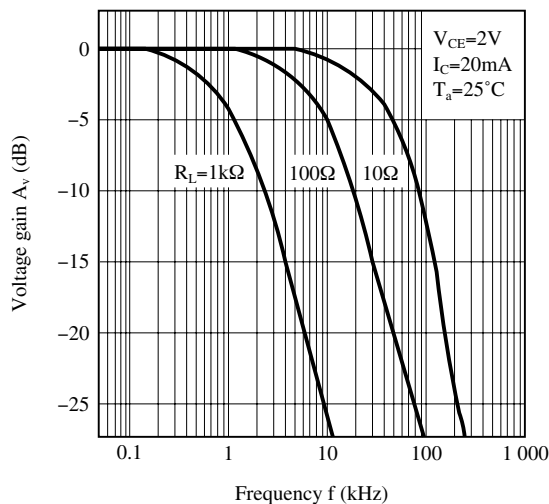
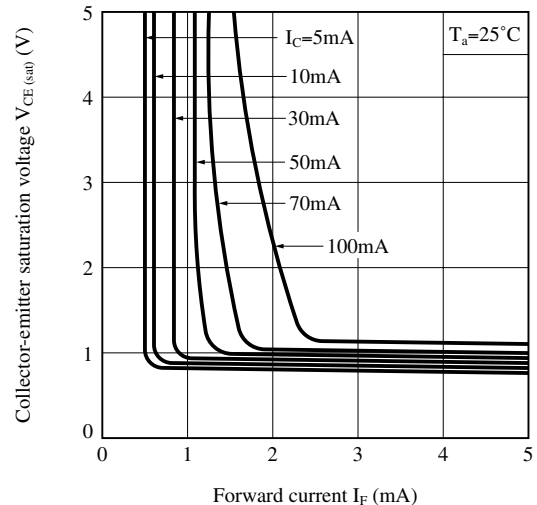

Fig.15 Collector-emitter Saturation Voltage vs. Forward Current



Remarks : Please be aware that all data in the graph are just for reference and not for guarantee.

■ **Design Considerations**

● **Design guide**

While operating at $I_F < 1.0\text{mA}$, CTR variation may increase.
Please make design considering this fact.

This product is not designed against irradiation and incorporates non-coherent IRED.

● **Degradation**

In general, the emission of the IRED used in photocouplers will degrade over time.
In the case of long term operation, please take the general IRED degradation (50% degradation over 5years) into the design consideration.

● **Recommended Foot Print (reference)**

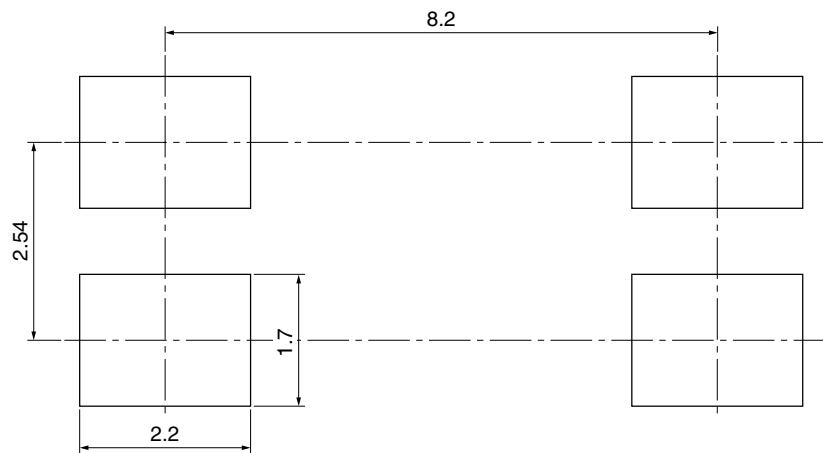

(Unit : mm)

☆ For additional design assistance, please review our corresponding Optoelectronic Application Notes.

■ Manufacturing Guidelines

● Soldering Method

Reflow Soldering:

Reflow soldering should follow the temperature profile shown below.

Soldering should not exceed the curve of temperature profile and time.

Please don't solder more than twice.

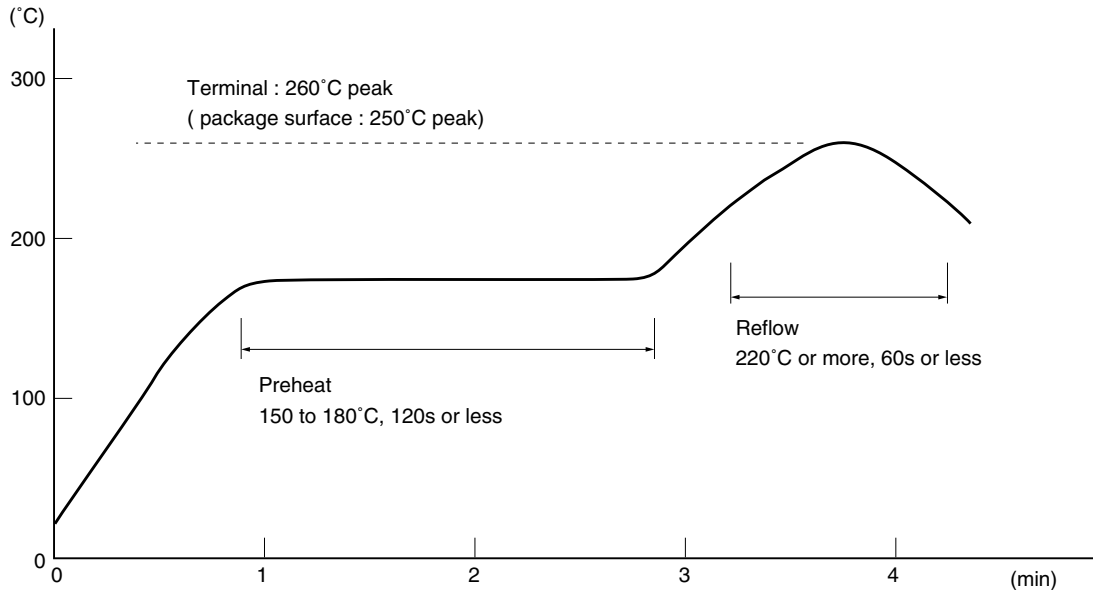

Flow Soldering :

Due to SHARP's double transfer mold construction submersion in flow solder bath is allowed under the below listed guidelines.

Flow soldering should be completed below 270°C and within 10s.

Preheating is within the bounds of 100 to 150°C and 30 to 80s.

Please don't solder more than twice.

Hand soldering

Hand soldering should be completed within 3s when the point of solder iron is below 400°C.

Please don't solder more than twice.

Other notices

Please test the soldering method in actual condition and make sure the soldering works fine, since the impact on the junction between the device and PCB varies depending on the tooling and soldering conditions.

● Cleaning instructions**Solvent cleaning:**

Solvent temperature should be 45°C or below Immersion time should be 3minutes or less

Ultrasonic cleaning:

The impact on the device varies depending on the size of the cleaning bath, ultrasonic output, cleaning time, size of PCB and mounting method of the device.

Therefore, please make sure the device withstands the ultrasonic cleaning in actual conditions in advance of mass production.

Recommended solvent materials:

Ethyl alcohol, Methyl alcohol and Isopropyl alcohol

In case the other type of solvent materials are intended to be used, please make sure they work fine in actual using conditions since some materials may erode the packaging resin.

● Presence of ODC

This product shall not contain the following materials.

And they are not used in the production process for this device.

Regulation substances:CFCs, Halon, Carbon tetrachloride, 1.1.1-Trichloroethane (Methylchloroform)

Specific brominated flame retardants such as the PBBOs and PBBs are not used in this product at all.

■ Package specification**● Sleeve package**

Package materials

Sleeve : HIPS (with anti-static material)

Stopper : Styrene-Elastomer

Package method

MAX. 100pcs of products shall be packaged in a sleeve. Both ends shall be closed by tabbed and tabless stoppers.

The product shall be arranged in the sleeve with its anode mark on the tabless stopper side.

MAX. 20 sleeves in one case.

Sleeve outline dimensions

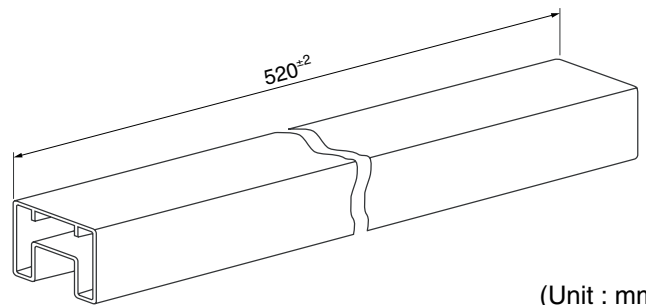
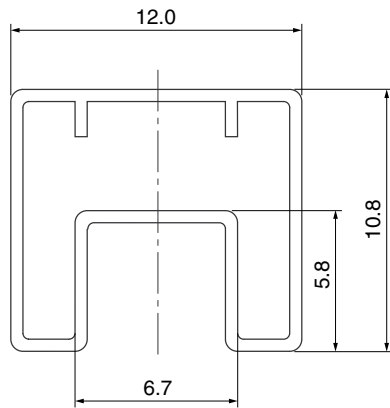

(Unit : mm)

● **Tape and Reel package**

Package materials

Carrier tape : PS

Cover tape : PET (three layer system)

Reel : PS

Carrier tape structure and Dimensions

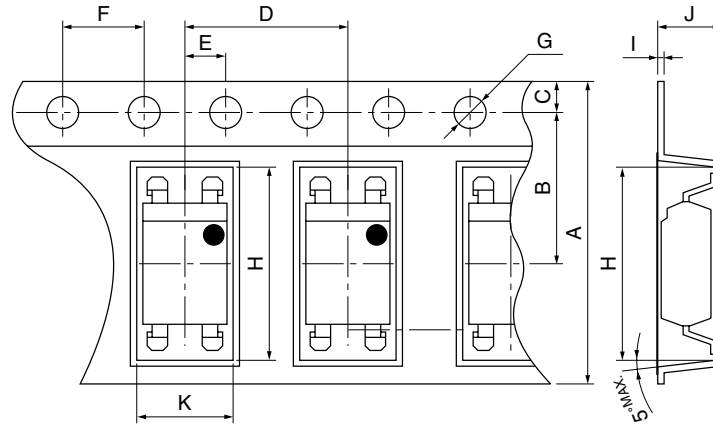

Dimensions List (Unit : mm)

A	B	C	D	E	F	G
16.0±0.3	7.5±0.1	1.75±0.1	8.0±0.1	2.0±0.1	4.0±0.1	φ1.5 ^{+0.1} ₀
H	I	J	K			
10.4±0.1	0.4±0.05	4.2±0.1	5.1±0.1			

Reel structure and Dimensions

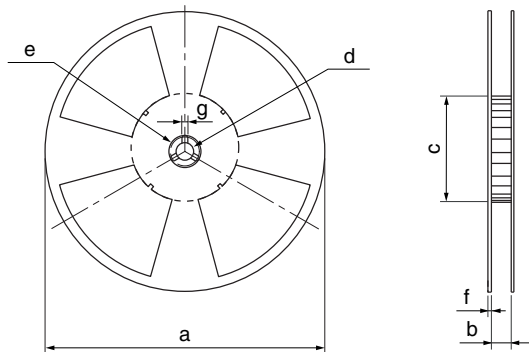

Dimensions List (Unit : mm)

a	b	c	d
330	17.5±1.5	100±1.0	13±0.5
e	f	g	
23±1.0	2.0±0.5	2.0±0.5	

Direction of product insertion

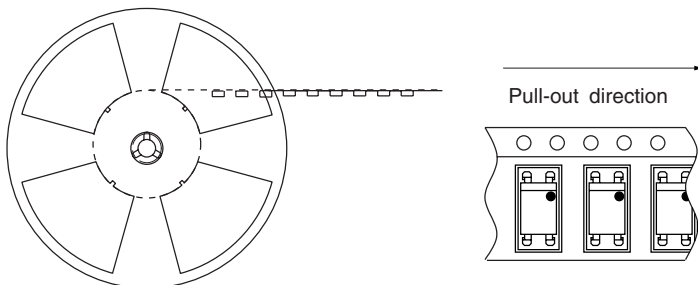

[Packing : 2 000pcs/reel]

■ Important Notices

· The circuit application examples in this publication are provided to explain representative applications of SHARP devices and are not intended to guarantee any circuit design or license any intellectual property rights. SHARP takes no responsibility for any problems related to any intellectual property right of a third party resulting from the use of SHARP's devices.

· Contact SHARP in order to obtain the latest device specification sheets before using any SHARP device. SHARP reserves the right to make changes in the specifications, characteristics, data, materials, structure, and other contents described herein at any time without notice in order to improve design or reliability. Manufacturing locations are also subject to change without notice.

· Observe the following points when using any devices in this publication. SHARP takes no responsibility for damage caused by improper use of the devices which does not meet the conditions and absolute maximum ratings to be used specified in the relevant specification sheet nor meet the following conditions:

(i) The devices in this publication are designed for use in general electronic equipment designs such as:

- Personal computers
- Office automation equipment
- Telecommunication equipment [terminal]
- Test and measurement equipment
- Industrial control
- Audio visual equipment
- Consumer electronics

(ii) Measures such as fail-safe function and redundant design should be taken to ensure reliability and safety when SHARP devices are used for or in connection

with equipment that requires higher reliability such as:

- Transportation control and safety equipment (i.e., aircraft, trains, automobiles, etc.)
- Traffic signals
- Gas leakage sensor breakers
- Alarm equipment
- Various safety devices, etc.

(iii) SHARP devices shall not be used for or in connection with equipment that requires an extremely high level of reliability and safety such as:

- Space applications
- Telecommunication equipment [trunk lines]
- Nuclear power control equipment
- Medical and other life support equipment (e.g., scuba).

· If the SHARP devices listed in this publication fall within the scope of strategic products described in the Foreign Exchange and Foreign Trade Law of Japan, it is necessary to obtain approval to export such SHARP devices.

· This publication is the proprietary product of SHARP and is copyrighted, with all rights reserved. Under the copyright laws, no part of this publication may be reproduced or transmitted in any form or by any means, electronic or mechanical, for any purpose, in whole or in part, without the express written permission of SHARP. Express written permission is also required before any use of this publication may be made by a third party.

· Contact and consult with a SHARP representative if there are any questions about the contents of this publication.